

proGAV[®]

Adjustable MIETHKE Shunt Systems
Your Simple Choice for Precise Patient Care

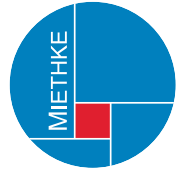

Aesculap Neurosurgery

proGAV®

Enhanced Patient Care

The *proGAV*® is the first adjustable gravitational valve for the treatment of pediatric and adult hydrocephalus. In its design it combines the advantages of an adjustable valve with those of a gravitational unit. It is also MR safe up to 3 Tesla.

In combination with the tried and tested Miethke *SHUNTASSISTANT*®, gravitational unit, the *proGAV*® offers effective protection against overdrainage.

The gravitational unit assists the adjustable differential pressure unit in maintaining physiological ventricular pressure independent of the patient's body position.

'The *proGAV*® shunt is an adjustable, low resistance valve that is able to limit posture-related overdrainage.

Unlike other adjustable valves, the *proGAV*® cannot be accidentally re-adjusted by external magnetic field such as a 3T MR scanner.'¹

¹Allin DM, Czosnyka ZH, Czosnyka M, Richards HK, Pickard JD. In vitro hydrodynamic properties of the Miethke *proGAV* hydrocephalus shunt. *Cerebrospinal Fluid Res.* 2006 Jun;3:9doi:10.1186/1743-8454-3-9.



- The patented adjustment and verification tools allow easy, fast and uncomplicated treatment at any location, without having to expose the patient to X-ray.
- The unique 'Active-Lock' mechanism protects the *proGAV*[®] against inadvertent readjustments caused by external magnetic fields.
- The unequalled opening pressure adjustment range of the *proGAV*[®], 0-20 cmH₂O, opens up more treatment options for the neurosurgeon, while the large adjustment radius of 300° ensures excellent adjusting precision.



proGAV[®]

Enhanced Treatment Options

- Wide range of pressure settings between 0 and 20 cmH₂O
- Patented instruments for easy and quick adjustment of the pressure level
- Integrated gravitational unit for effective protection against overdrainage
- Titanium shell allowing reliable operation independent of external or subcutaneous pressures
- 'Active-Lock' mechanism to reduce inadvertent pressure level readjustments caused by external magnetic fields
- 3 Tesla MR safe
- X-ray-free verification of the pressure level setting

'From the clinical point of view, the programmable gravity-assisted valve *proGAV*[®] is an indispensable development in the valve manufactory technique, offering a new standard in the management of iNPH.'

Meier U, Lemcke J, Al-Zain F. Clinical experiences in the treatment of idiopathic normal-pressure hydrocephalus using the programmable gravity assisted valve *proGAV*[®] Aesculap. *Neurosurg Q.* 2007;17(1):52-5.



Our Recommendation

Adjustable differential pressure unit

Standard (NPH-patients)	5 cmH ₂ O
Defensive (e.g. patients with extremely wide ventricles and highly elevated ICP or aqueductal stenosis)	10 cmH ₂ O

Gravitational unit

Children up to 5 years	20 cmH ₂ O
Children over 5 years and adults up to 60 years	25 cmH ₂ O
Adults over 60 years	20 cmH ₂ O

Mobility

Standard pressure levels are suitable for active people. Bedridden patients should not be treated with a gravitational unit.

Height

The hydrostatic suction effect normally depends on the height. For adults we therefore recommend the following corrections for the gravitational unit:

- < 1.60 m height: 5 cmH₂O below recommendation
- > 1.80 m height: 5 cmH₂O above recommendation

* These guide values are not binding. Other settings may be preferable depending on the individual patient and anamnesis.

proGAV®
in X-ray view

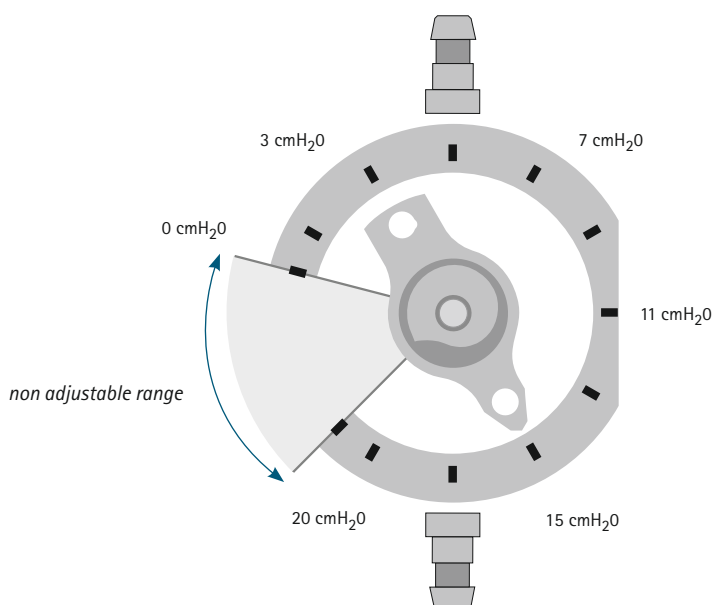

proGAV®

Supine Function

The proGAV® is a position-dependent valve. The opening pressure of the valve varies continuously with the patient's body position. To adapt the proGAV® to the individual patient, one opening pressure is selected for the supine position and one for the upright position.

- The opening pressure for the supine position is defined exclusively by the adjustable differential pressure unit. The gravitational unit does not influence the opening pressure in this body position.

- The opening pressure can be set to a value between 0 and 20 cmH₂O, depending on clinical presentation and indication.

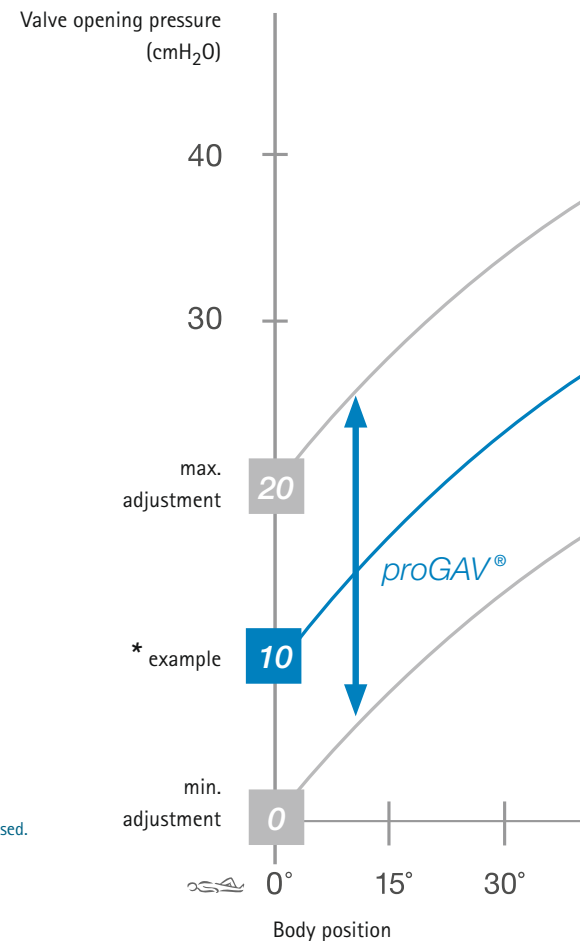
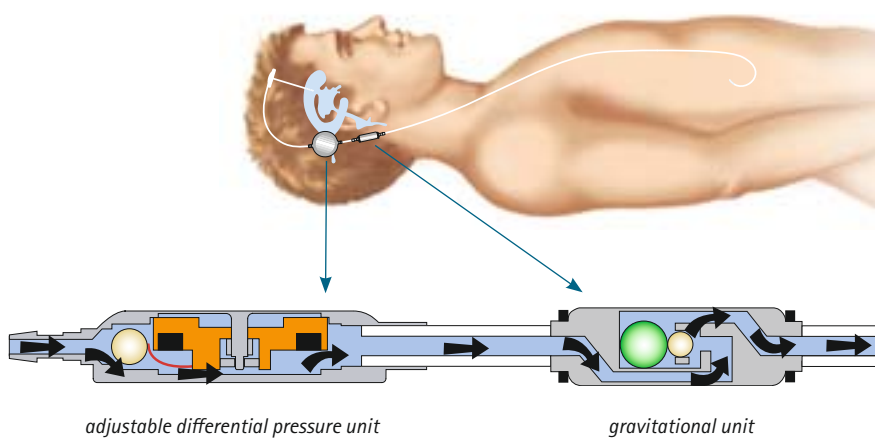

* Example: The adjustable unit is adjusted to 10 cmH₂O and a gravitational unit with an opening pressure of 25 cmH₂O is used. The total valve opening pressure in the supine position is 10 cmH₂O. (10 cmH₂O + 0 cmH₂O = 10 cmH₂O) The total valve opening pressure in the upright position is 35 cmH₂O. (10 cmH₂O + 25 cmH₂O = 35 cmH₂O)

Upright Function

The gravitational unit is activated whenever the patient moves to an upright position.

- As the patient moves to an upright position, the tantalum weight ball is activated and provides a gradually increasing opening pressure of the shunt system.
- In this mode the shunt opening pressure is the sum of the pressure level set at the adjustable differential pressure unit and the increasing opening pressure of the gravitational unit.

- The continuous increase of the opening pressure, up to the maximum when the patient is fully upright, offers effective protection against overdrainage.

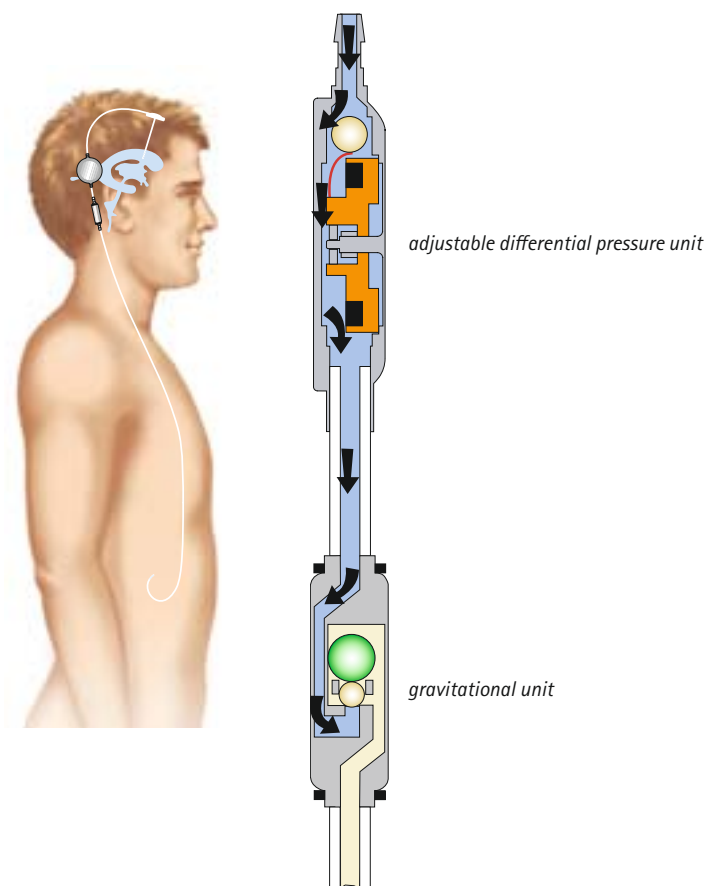
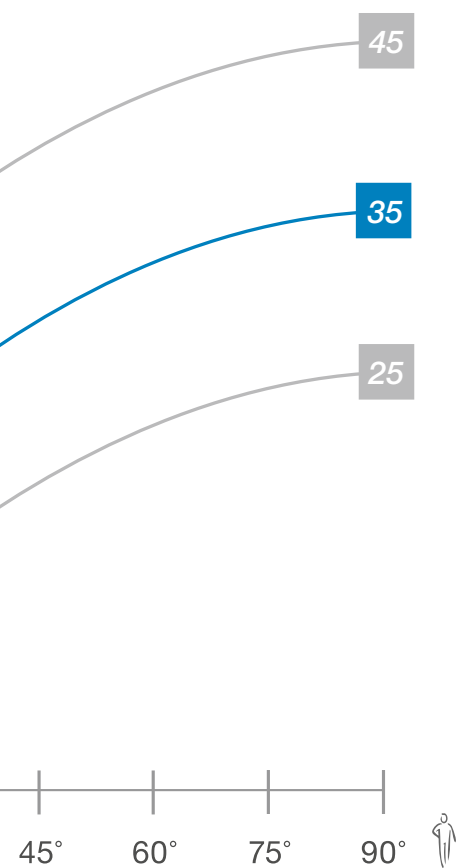

Instruments for Valve Adjustment

Localisation

The *proGAV*® is located by palpation.

This procedure is aided by the *proGAV*® *Compass* which can also be used for reading the actual opening pressure setting.

The *proGAV*® *Compass* is an auxiliary instrument for locating the *proGAV*®. As the compass is held above the valve implant site, the floater aligns over the adjustable *proGAV*® valve. The present opening pressure setting can be read from the compass scale.

Verification

Position the *proGAV*® *Verification Tool* according to instruction for use on the valve. The marking and the display of the *proGAV*® *Verification Tool* must be in line with the proximal (ventricular) catheter. Press the trigger button to see the actual opening pressure setting displayed in the display window.

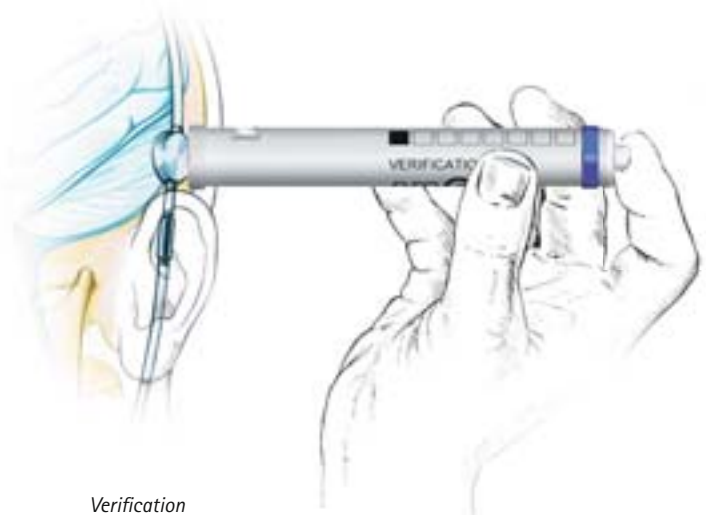

Adjustment

Select the appropriate opening pressure on the *proGAV*[®] Adjustment Tool. Position the *proGAV*[®] Adjustment Tool according to instruction for use on the valve. The marking and the display of the *proGAV*[®] Adjustment Tool must be in line with the proximal (ventricular) catheter. Unlock the mechanical coupling 'Active-Lock' by applying mild pressure on the trigger button and set the intended opening pressure. Control the setting with the *proGAV*[®] Verification Tool.

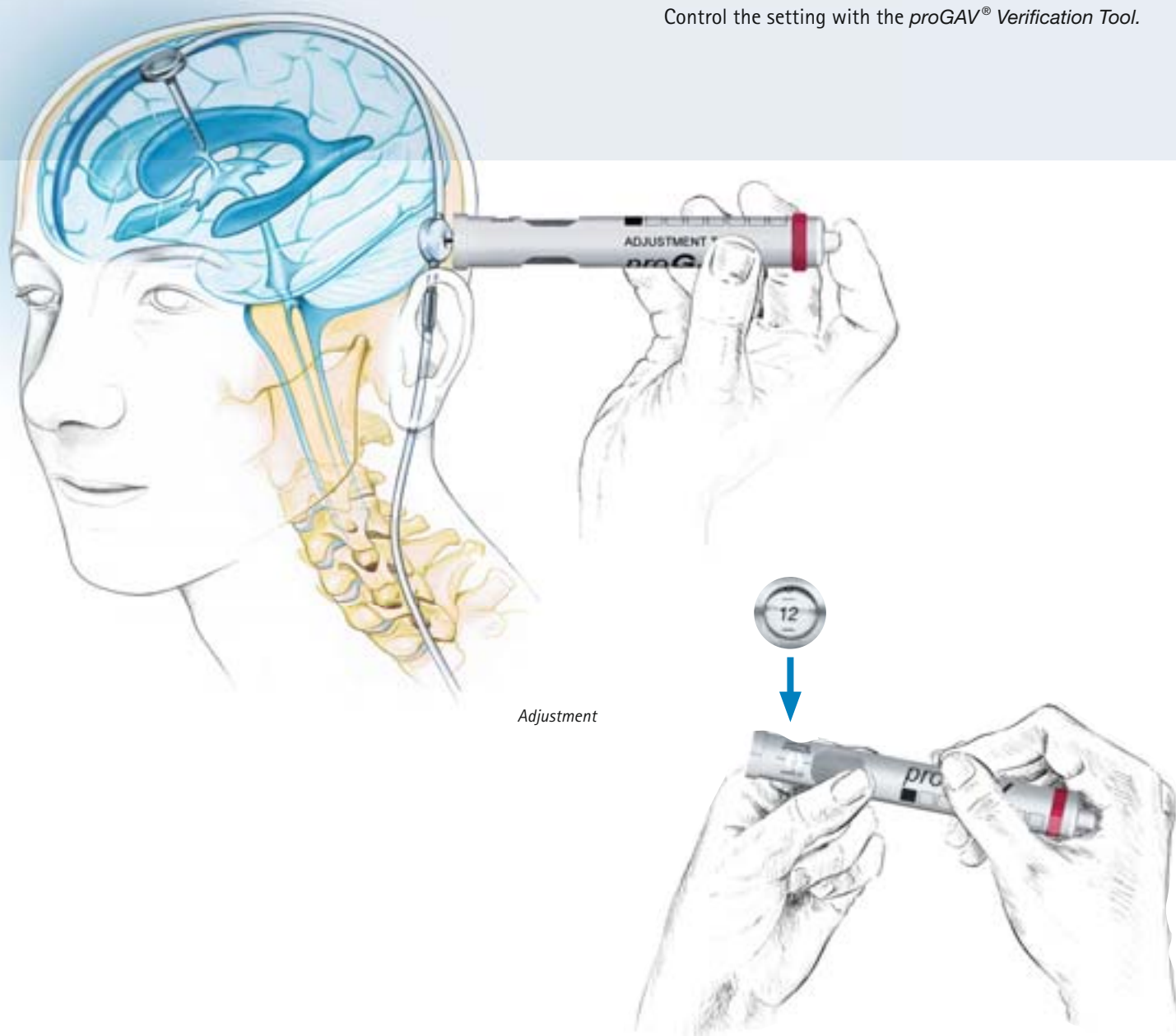

Adjustment

- Available as adjustable differential pressure unit only or in combination with gravitational unit
- Adjustable between 0 - 20 cmH₂O

Without gravitational unit:

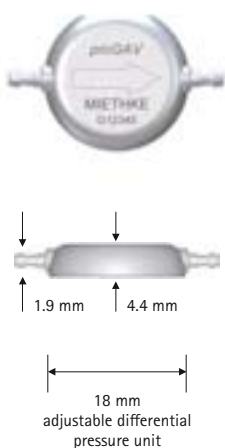

With gravitational unit:

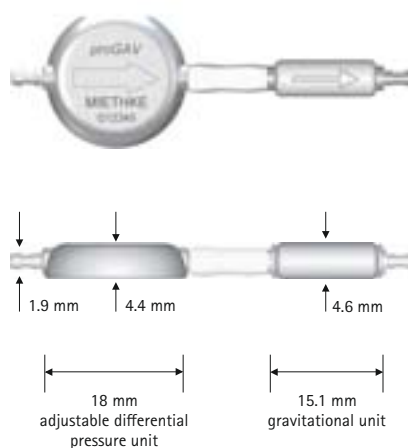

Connector: $d_o = 1.9 \text{ mm}$
 Adj. diff. pressure unit: $d_o = 4.4 \text{ mm}$
 Gravitational unit: $d_o = 4.6 \text{ mm}$
 Catheter: $d_i = 1.2 \text{ mm}$
 $d_o = 2.5 \text{ mm}$

Scale 1:1

Cat. no.	Gravitational unit (not adjustable / cmH ₂ O*)
Children up to 5 years and adults over 60 years: FV413T **	20
Children over 5 years and adults up to 60 years: FV414T **	25
Special pressure levels	
FV410T	-
FV411T	10
FV412T	15
FV415T	30
FV416T	35

* 1 cmH₂O = 0.74 mmHg

** Standard pressure levels. These guide values are not binding.

Other specifications may be preferable depending on the individual patient and anamnesis.

proGAV® with distal catheter

- Available as adjustable differential pressure unit with integrated distal catheter only or in combination with gravitational unit
- Adjustable between 0 - 20 cmH₂O

Without gravitational unit:

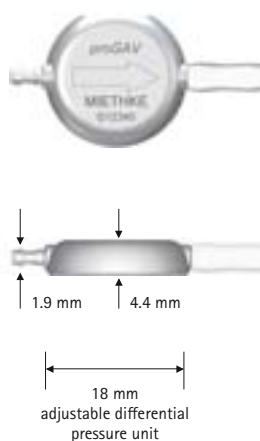

With gravitational unit:

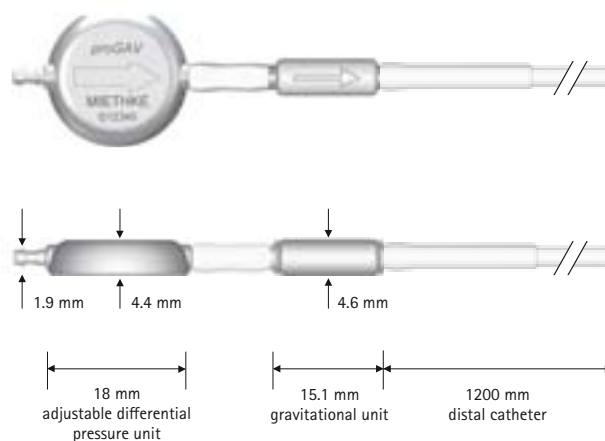

Connector: $d_o = 1.9 \text{ mm}$
 Adj. diff. pressure unit: $d_o = 4.4 \text{ mm}$
 Gravitational unit: $d_o = 4.6 \text{ mm}$
 Catheter: $d_i = 1.2 \text{ mm}$
 $d_o = 2.5 \text{ mm}$

Scale 1:1

Cat. no.	Gravitational unit (not adjustable / cmH ₂ O*)
Children up to 5 years and adults over 60 years: FV420T **	20
Children over 5 years and adults up to 60 years: FV421T **	25
Special pressure levels	
FV417T	-
FV418T	10
FV419T	15
FV422T	30
FV423T	35

* 1 cmH₂O = 0.74 mmHg

** Standard pressure levels. These guide values are not binding.

Other specifications may be preferable depending on the individual patient and anamnesis.

proGAV® SHUNTSYSTEM with SPRUNG RESERVOIR

■ Ventricular catheter with introducing stylet

■ **SPRUNG RESERVOIR*** with integrated distal catheter, design acc. to Dr. Sprung

* Flushing reservoir allows for the checking of the ventricular catheter's patency and ensures only distal drainage.

■ Available as adjustable differential pressure unit with distal catheter only or in combination with gravitational unit

■ Adjustable between 0 - 20 cmH₂O

Connector:	d _o = 1.9 mm
Adj. diff. pressure unit:	d _o = 4.4 mm
Gravitational unit:	d _o = 4.6 mm
Catheter:	d _i = 1.2 mm
	d _o = 2.5 mm

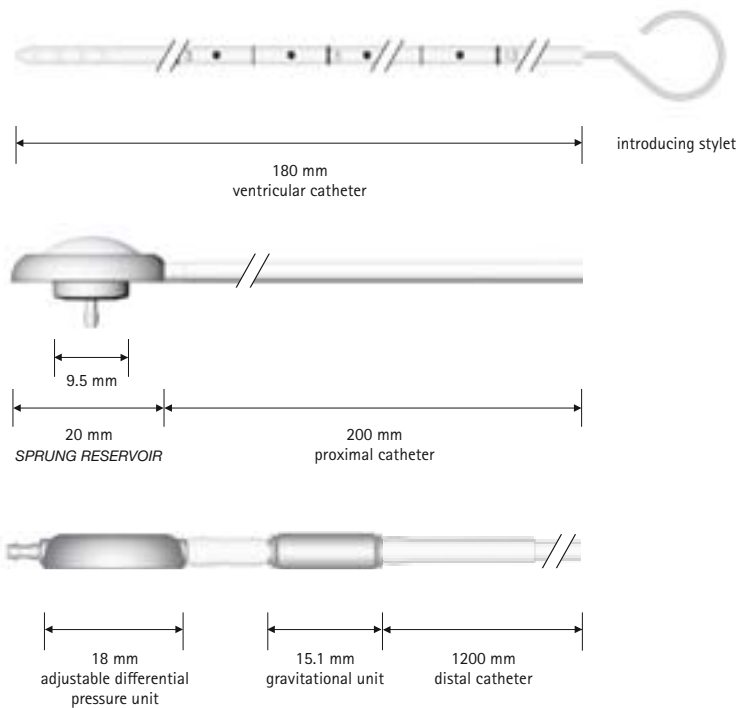

Scale 1:1

Cat. no.	Gravitational unit (not adjustable / cmH ₂ O*)
Children up to 5 years and adults over 60 years: FV427T **	20
Children over 5 years and adults up to 60 years: FV428T **	25

■ Special pressure levels

FV424T	-
FV425T	10
FV426T	15
FV429T	30
FV430T	35

* 1 cmH₂O = 0.74 mmHg

** Standard pressure levels. These guide values are not binding.

Other specifications may be preferable depending on the individual patient and anamnesis.

proGAV® with CONTROL RESERVOIR

- Available as adjustable differential pressure unit only with integrated CONTROL RESERVOIR*

* Flushing reservoir allows for the checking of the ventricular catheter's patency and ensures only distal drainage.

- Adjustable between 0 - 20 cmH₂O

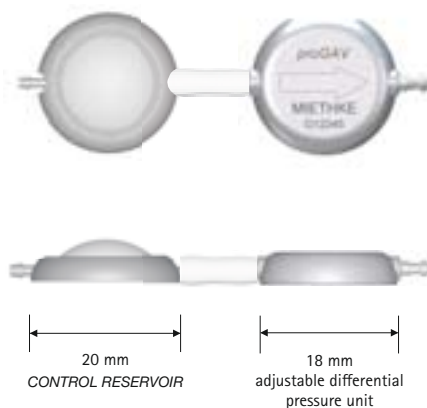

Connector: $d_o = 1.9 \text{ mm}$
 Adj. diff. pressure unit: $d_o = 4.4 \text{ mm}$
 Catheter: $d_i = 1.2 \text{ mm}$
 $d_o = 2.5 \text{ mm}$

Scale 1:1

Cat. no.	Gravitational unit (not adjustable / cmH ₂ O*)
FV467T	-

* 1 cmH₂O = 0.74 mmHg

proGAV® SHUNTSYSTEM with CONTROL RESERVOIR

- Ventricular catheter with introducing stylet and deflector
- Available as adjustable differential pressure unit only or in combination with gravitational unit
- Adjustable between 0 - 20 cmH₂O
- With integrated distal catheter and CONTROL RESERVOIR*

* Flushing reservoir allows for the checking of the ventricular catheter's patency and ensures only distal drainage.

Connector:	d _o = 1.9 mm
Adj. diff. pressure unit:	d _o = 4.4 mm
Gravitational unit:	d _o = 4.6 mm
Catheter:	d _i = 1.2 mm
	d _o = 2.5 mm

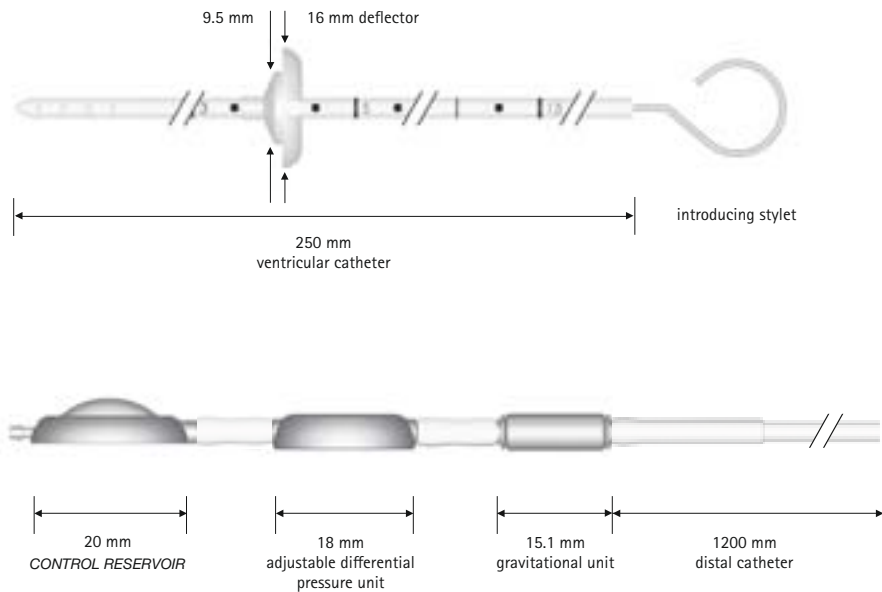

Scale 1:1

Cat. no.	Gravitational unit (not adjustable / cmH ₂ O*)
Children up to 5 years and adults over 60 years: FV434T **	20
Children over 5 years and adults up to 60 years: FV435T **	25

■ Special pressure levels

FV431T	-
FV432T	10
FV433T	15
FV436T	30
FV437T	35

* 1 cmH₂O = 0.74 mmHg

** Standard pressure levels. These guide values are not binding.

Other specifications may be preferable depending on the individual patient and anamnesis.

proGAV® SHUNTSYSTEM with CONTROL RESERVOIR

- Ventricular catheter with introducing stylet and deflector
 - Available as adjustable differential pressure unit only or in combination with gravitational unit
 - With integrated CONTROL RESERVOIR*
- * Flushing reservoir allows for the checking of the ventricular catheter's patency and ensures only distal drainage.
- Distal catheter and proximal catheter with integrated gravitational unit

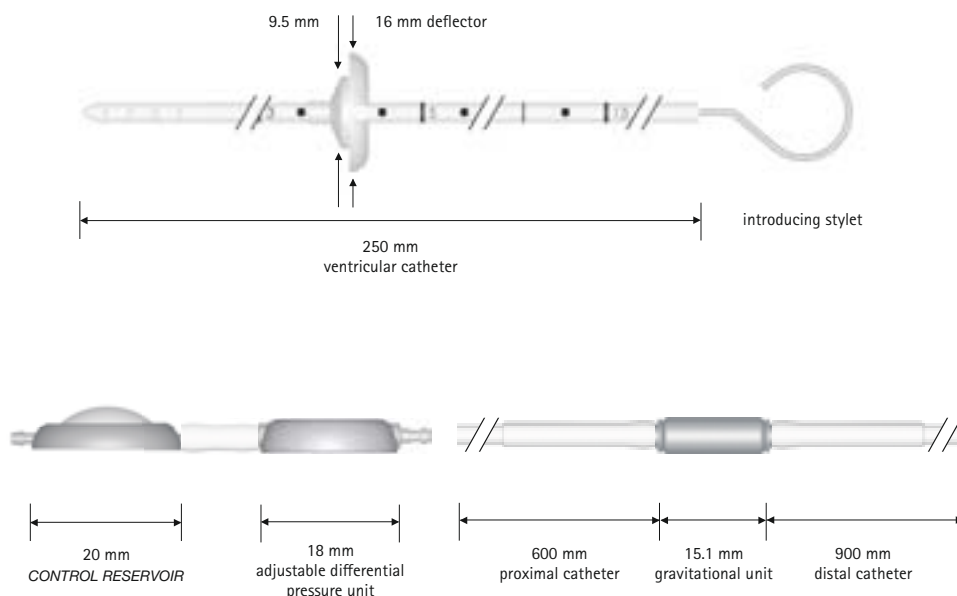

Connector: $d_o = 1.9 \text{ mm}$
 Adj. diff. pressure unit: $d_o = 4.4 \text{ mm}$
 Gravitational unit: $d_o = 4.6 \text{ mm}$
 Catheter: $d_i = 1.2 \text{ mm}$
 $d_o = 2.5 \text{ mm}$

Scale 1:1

Cat. no.	Gravitational unit (not adjustable / cmH ₂ O*)
Children up to 5 years and adults over 60 years: FV462T**	20
Children over 5 years and adults up to 60 years: FV463T**	25

■ Special pressure levels

FV459T	-
FV460T	10
FV461T	15
FV464T	30
FV465T	35

* 1 cmH₂O = 0.74 mmHg

** Standard pressure levels. These guide values are not binding.

Other specifications may be preferable depending on the individual patient and anamnesis.

proGAV® with pediatric prechamber

Available as adjustable differential pressure unit only with integrated pediatric prechamber

Adjustable between 0 - 20 cmH₂O

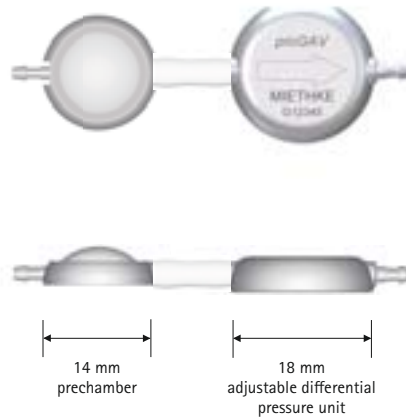

Connector: $d_o = 1.9$ mm
 Adj. diff. pressure unit: $d_o = 4.4$ mm
 Catheter: $d_i = 1.2$ mm
 $d_o = 2.5$ mm

Scale 1:1

Cat. no.	Gravitational unit (not adjustable / cmH ₂ O*)
FV466T	-

* 1 cmH₂O = 0.74 mmHg

proGAV® SHUNTSYSTEM with pediatric prechamber

- Ventricular catheter with introducing stylet and pediatric deflector
- Available as adjustable differential pressure unit only or in combination with gravitational unit
- Adjustable between 0 - 20 cmH₂O
- With integrated distal catheter and pediatric prechamber

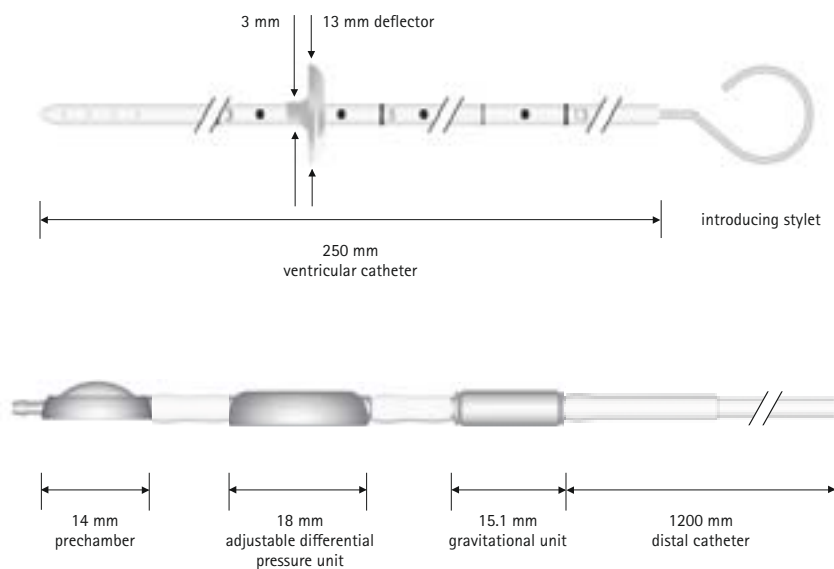

Connector: $d_o = 1.9$ mm
 Adj. diff. pressure unit: $d_o = 4.4$ mm
 Gravitational unit: $d_o = 4.6$ mm
 Catheter: $d_i = 1.2$ mm
 $d_o = 2.5$ mm

Scale 1:1

Cat. no.	Gravitational unit (not adjustable / cmH ₂ O*)
Children up to 5 years and adults over 60 years: FV441T **	20
Children over 5 years and adults up to 60 years: FV442T **	25

■ Special pressure levels

FV438T	-
FV439T	10
FV440T	15
FV443T	30
FV444T	35

* 1 cmH₂O = 0.74 mmHg

** Standard pressure levels. These guide values are not binding.

Other specifications may be preferable depending on the individual patient and anamnesis.

proGAV® SHUNTSYSTEM with pediatric prechamber

- Ventricular catheter with introducing stylet and pediatric deflector
- Available as adjustable differential pressure unit with integrated pediatric prechamber
- Adjustable between 0 - 20 cmH₂O
- Distal catheter only (1200 mm) or in combination with integrated gravitational unit and proximal catheter

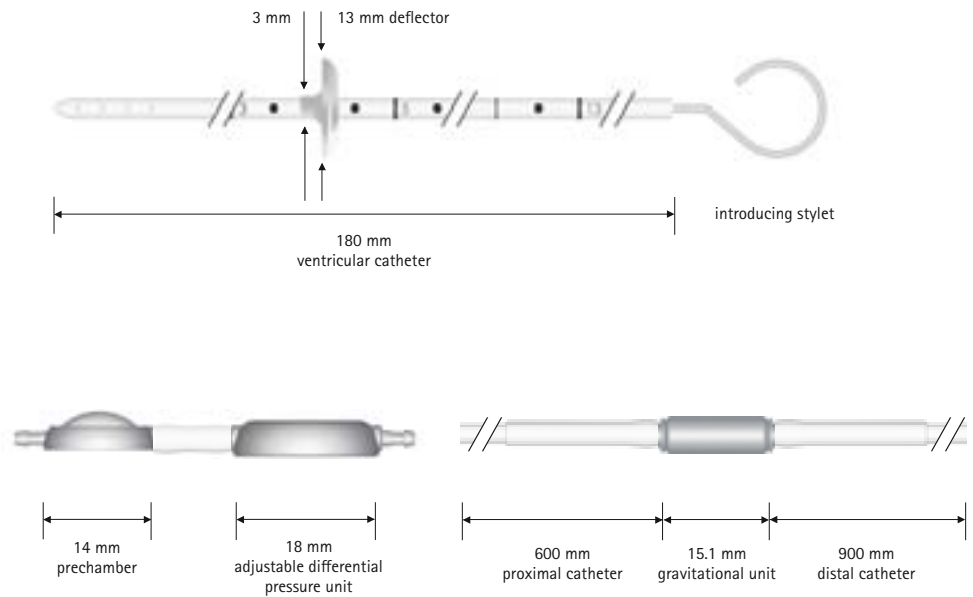

Connector: $d_o = 1.9 \text{ mm}$
 Adj. diff. pressure unit: $d_o = 4.4 \text{ mm}$
 Gravitational unit: $d_o = 4.6 \text{ mm}$
 Catheter: $d_i = 1.2 \text{ mm}$
 $d_o = 2.5 \text{ mm}$

Scale 1:1

Cat. no.	Gravitational unit (not adjustable / cmH ₂ O*)
Children up to 5 years and adults over 60 years: FV455T **	20
Children over 5 years and adults up to 60 years: FV456T **	25
Special pressure levels	
FV452T	-
FV453T	10
FV454T	15
FV457T	30
FV458T	35

* 1 cmH₂O = 0.74 mmHg

** Standard pressure levels. These guide values are not binding.

Other specifications may be preferable depending on the individual patient and anamnesis.

proGAV® with pediatric burrhole reservoir

Available as adjustable differential pressure unit with integrated pediatric burrhole reservoir only or in combination with integrated gravitational unit

Adjustable between 0 - 20 cmH₂O

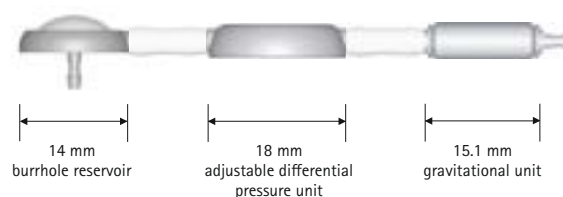

Connector: $d_o = 1.9$ mm
 Adj. diff. pressure unit: $d_o = 4.4$ mm
 Gravitational unit: $d_o = 4.6$ mm
 Catheter: $d_i = 1.2$ mm
 $d_o = 2.5$ mm

Scale 1:1

Cat. no.	Gravitational unit (not adjustable / cmH ₂ O*)
Children up to 5 years and adults over 60 years: FV485T **	20
Special pressure levels	
FV490T	-
FV483T	10
FV484T	15
FV488T	25
FV486T	30
FV487T	35

* 1 cmH₂O = 0.74 mmHg

** Standard pressure levels. These guide values are not binding.

Other specifications may be preferable depending on the individual patient and anamnesis.

proGAV® SHUNTSYSTEM with pediatric burrhole reservoir

- Ventricular catheter with introducing stylet
- Pediatric burrhole reservoir with integrated proximal catheter
- Available as adjustable differential pressure unit only or in combination with gravitational unit
- Adjustable between 0 - 20 cmH₂O

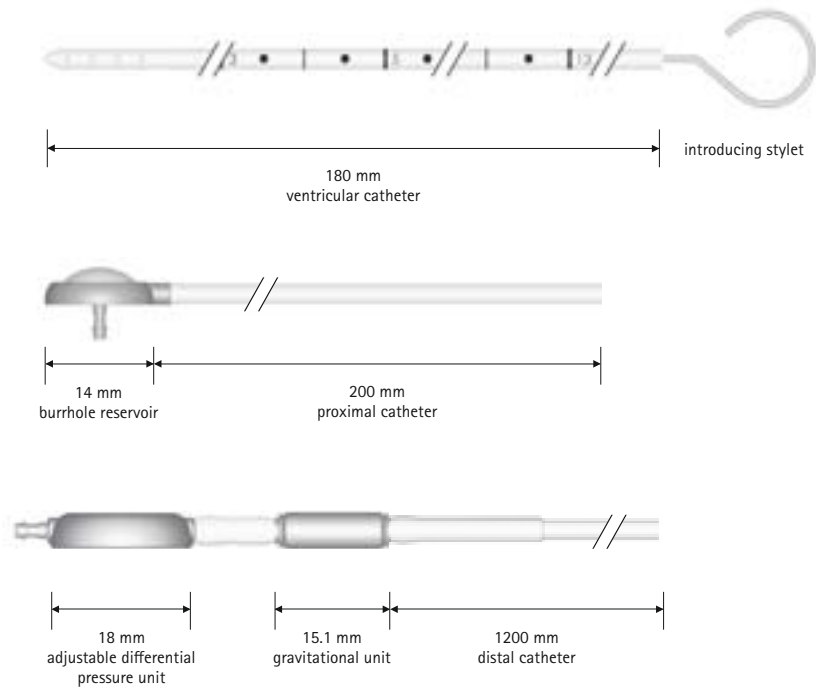

Connector: $d_o = 1.9 \text{ mm}$
 Adj. diff. pressure unit: $d_o = 4.4 \text{ mm}$
 Gravitational unit: $d_o = 4.6 \text{ mm}$
 Catheter: $d_i = 1.2 \text{ mm}$
 $d_o = 2.5 \text{ mm}$

Scale 1:1

Cat. no.	Gravitational unit (not adjustable / cmH ₂ O*)
Children up to 5 years and adults over 60 years: FV448T**	20
Children over 5 years and adults up to 60 years: FV449T**	25
■ Special pressure levels	
FV445T	-
FV446T	10
FV447T	15
FV450T	30
FV451T	35

* 1 cmH₂O = 0.74 mmHg

** Standard pressure levels. These guide values are not binding.

Other specifications may be preferable depending on the individual patient and anamnesis.

proGAV® SHUNTSYSTEM with pediatric burrhole reservoir

- Ventricular catheter with introducing stylet
- Available as adjustable differential pressure unit only or in combination with gravitational unit
- Adjustable between 0 - 20 cmH₂O
- With integrated distal catheter and pediatric burrhole reservoir

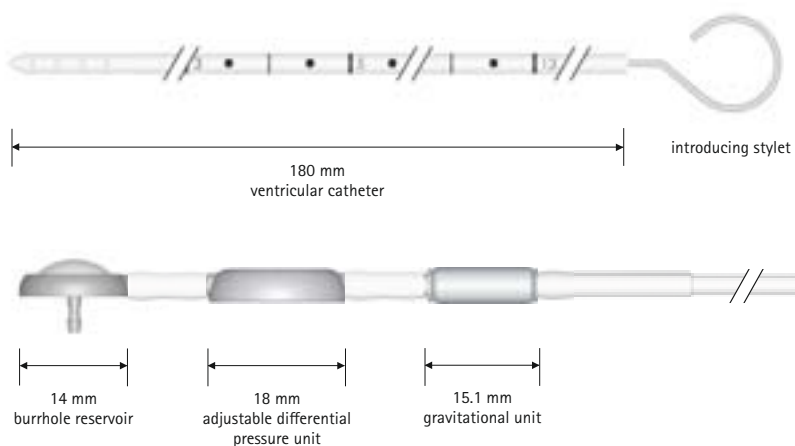

Connector: $d_o = 1.9 \text{ mm}$
 Adj. diff. pressure unit: $d_o = 4.4 \text{ mm}$
 Gravitational unit: $d_o = 4.6 \text{ mm}$
 Catheter: $d_i = 1.2 \text{ mm}$
 $d_o = 2.5 \text{ mm}$

Scale 1:1

Cat. no.	Gravitational unit (not adjustable / cmH ₂ O*)
Children up to 5 years and adults over 60 years: FV471T**	20
■ Special pressure levels	
FV468T	-
FV469T	10
FV470T	15
FV472T	25
FV473T	30
FV474T	35

* 1 cmH₂O = 0.74 mmHg

** Standard pressure levels. These guide values are not binding.

Other specifications may be preferable depending on the individual patient and anamnesis.

proGAV® SHUNTSYSTEM with distal catheter

- Ventricular catheter with introducing stylet and deflector
- Available as adjustable differential pressure unit with integrated distal catheter and gravitational unit
- Adjustable between 0 - 20 cmH₂O

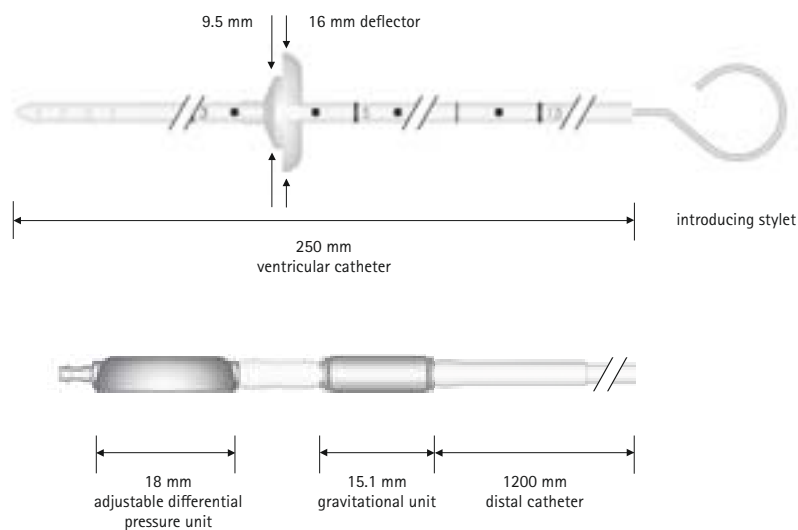

Connector:	$d_o = 1.9 \text{ mm}$
Adj. diff. pressure unit:	$d_o = 4.4 \text{ mm}$
Gravitational unit:	$d_o = 4.6 \text{ mm}$
Catheter:	$d_i = 1.2 \text{ mm}$ $d_o = 2.5 \text{ mm}$

Scale 1:1

Cat. no.	Gravitational unit (not adjustable / cmH ₂ O*)
Children up to 5 years and adults over 60 years: FV489T**	25

* 1 cmH₂O = 0.74 mmHg

** Standard pressure levels. These guide values are not binding.

Other specifications may be preferable depending on the individual patient and anamnesis.

proGAV® with SPRUNG RESERVOIR

- Adjustable differential pressure unit only with **SPRUNG RESERVOIR*** without connection

* Flushing reservoir allows for the checking of the ventricular catheter's patency and ensures only distal drainage.

- Adjustable between 0 - 20 cmH₂O

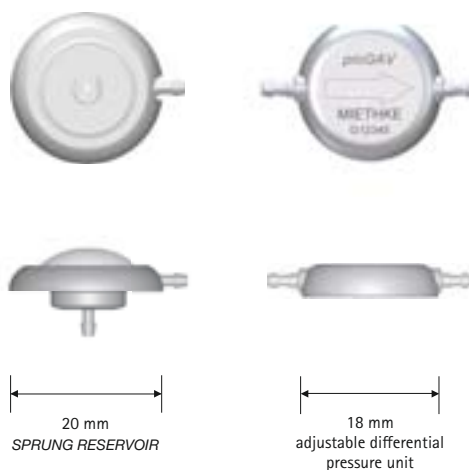

Connector: $d_o = 1.9 \text{ mm}$
 Adj. diff. pressure unit: $d_o = 4.4 \text{ mm}$

Scale 1:1

Cat. no.	Gravitational unit (not adjustable / cmH ₂ O*)
Children up to 5 years and adults over 60 years: FV475T	-

proGAV® SHUNTSYSTEM with CONTROL RESERVOIR

- Ventricular catheter with introducing stylet and pediatric deflector
- Available as adjustable differential pressure unit only or in combination with gravitational unit
- Adjustable between 0 - 20 cmH₂O
- With integrated distal catheter and CONTROL RESERVOIR*

* Flushing reservoir allows for the checking of the ventricular catheter's patency and ensures only distal drainage.

Connector:	d _o = 1.9 mm
Adj. diff. pressure unit:	d _o = 4.4 mm
Gravitational unit:	d _o = 4.6 mm
Catheter:	d _i = 1.2 mm
	d _o = 2.5 mm

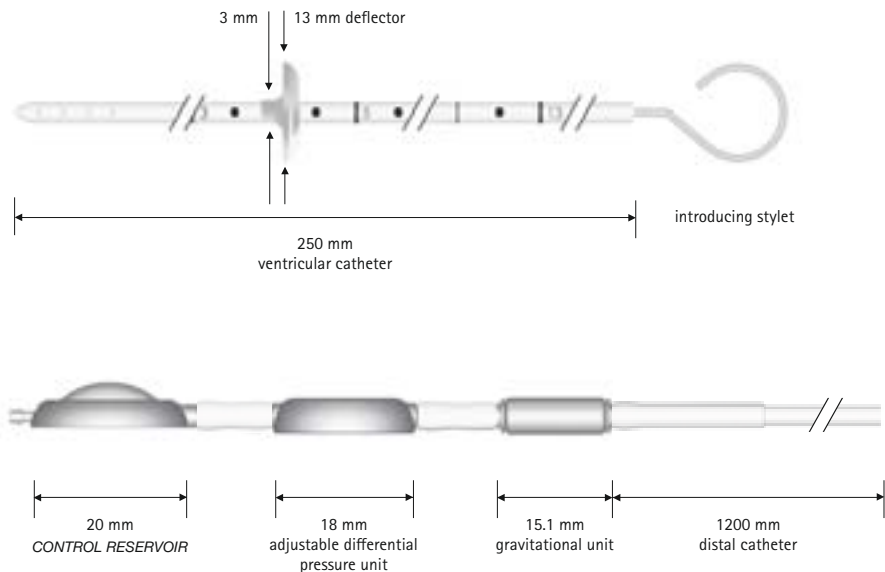

Scale 1:1

Cat. no.	Gravitational unit (not adjustable / cmH ₂ O*)
Children up to 5 years and adults over 60 years: FV482T**	25
Special pressure levels	
FV481T	20

* 1 cmH₂O = 0.74 mmHg

** Standard pressure levels. These guide values are not binding.

Other specifications may be preferable depending on the individual patient and anamnesis.

proGAV® with CONTROL RESERVOIR

- Available as adjustable differential pressure unit with integrated CONTROL RESERVOIR* only or in combination with gravitational unit

* Flushing reservoir allows for the checking of the ventricular catheter's patency and ensures only distal drainage.

- Adjustable between 0 - 20 cmH₂O

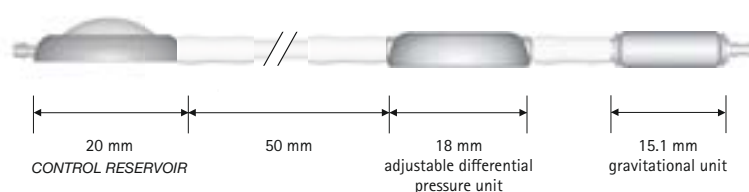

Connector: $d_o = 1.9 \text{ mm}$
 Adj. diff. pressure unit: $d_o = 4.4 \text{ mm}$
 Gravitational unit: $d_o = 4.6 \text{ mm}$
 Catheter: $d_i = 1.2 \text{ mm}$
 $d_o = 2.5 \text{ mm}$

Scale 1:1

Cat. no.	Gravitational unit (not adjustable / cmH ₂ O*)
FV491T	-
FV492T	30

* 1 cmH₂O = 0.74 mmHg

proGAV® with CONTROL RESERVOIR

- Available as adjustable differential pressure unit with integrated CONTROL RESERVOIR* with integrated gravitational unit

* Flushing reservoir allows for the checking of the ventricular catheter's patency and ensures only distal drainage.

- Adjustable between 0 - 20 cmH₂O

Connector: $d_o = 1.9$ mm
 Adj. diff. pressure unit: $d_o = 4.4$ mm
 Gravitational unit: $d_o = 4.6$ mm
 Catheter: $d_i = 1.2$ mm
 $d_o = 2.5$ mm

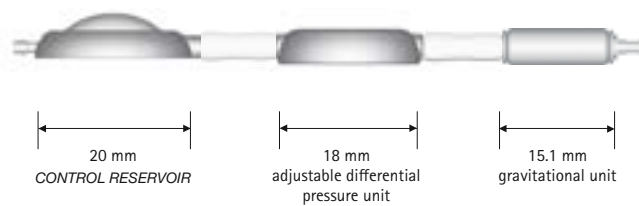

Scale 1:1

Cat. no.	Gravitational unit (not adjustable / cmH ₂ O*)
Children up to 5 years and adults over 60 years: FV479T**	25
Special pressure levels	
FV476T	10
FV477T	15
FV478T	20

* 1 cmH₂O = 0.74 mmHg

** Standard pressure levels. These guide values are not binding.

Other specifications may be preferable depending on the individual patient and anamnesis.

proGAV® SHUNTSYSTEM with prechamber

- Ventricular catheter with introducing stylet and deflector
- Available as adjustable differential pressure unit with integrated prechamber
- Adjustable between 0 - 20 cmH₂O
- Proximal catheter with integrated gravitational unit and distal catheter

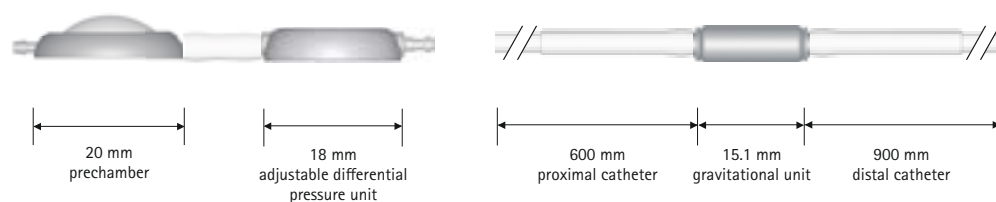
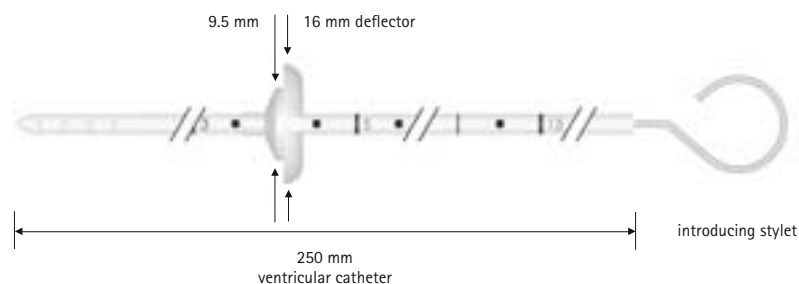

Connector: $d_o = 1.9 \text{ mm}$
 Adj. diff. pressure unit: $d_o = 4.4 \text{ mm}$
 Gravitational unit: $d_o = 4.6 \text{ mm}$
 Catheter: $d_i = 1.2 \text{ mm}$
 $d_o = 2.5 \text{ mm}$

Scale 1:1

Cat. no.	Gravitational unit (not adjustable / cmH ₂ O*)
Children up to 5 years and adults over 60 years: FV496T**	25
■ Special pressure levels	
FV493T	10
FV494T	15
FV495T	20
FV497T	30
FV498T	35

* 1 cmH₂O = 0.74 mmHg

** Standard pressure levels. These guide values are not binding.

Other specifications may be preferable depending on the individual patient and anamnesis.

proGAV® with pediatric prechamber

- Available as adjustable differential pressure unit with integrated gravitational unit
- Adjustable between 0 - 20 cmH₂O
- With integrated distal catheter and pediatric prechamber

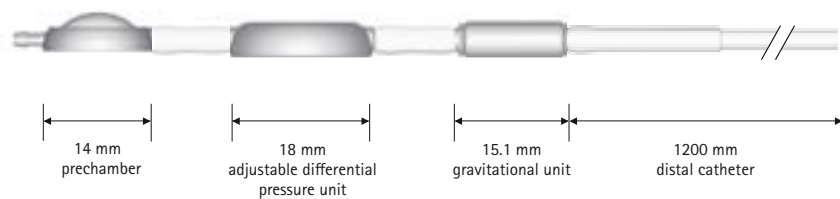

Connector: $d_o = 1.9$ mm
 Adj. diff. pressure unit: $d_o = 4.4$ mm
 Gravitational unit: $d_o = 4.6$ mm
 Catheter: $d_i = 1.2$ mm
 $d_o = 2.5$ mm

Scale 1:1

Cat. no.	Gravitational unit (not adjustable / cmH ₂ O*)
Children up to 5 years and adults over 60 years: FV480T**	20

* 1 cmH₂O = 0.74 mmHg

** Standard pressure levels. These guide values are not binding.

Other specifications may be preferable depending on the individual patient and anamnesis.

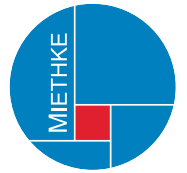

proGAV® Tools

Tools for valve adjustment

- *proGAV® Adjustment Tool*
Tool for setting the required opening pressure
- *proGAV® Verification Tool*
Tool for reading the actual opening pressure setting



proGAV® Adjustment Tool



proGAV® Verification Tool

Cat. no.	Tools
FV400T	<i>proGAV® Adjustment Tool</i>
FV401T	<i>proGAV® Verification Tool</i>

proGAV® Tools

Tools for valve adjustment

- *proGAV® Masterdisc* for calibrating the verification tool
- *proGAV® Compass* for locating and measuring the *proGAV®*
- *proGAV® Adjustment Disc* for setting the required opening pressure
- *proGAV® Check-mate* sterilisable, for reading and setting the opening pressure in the operating room



proGAV® Compass



proGAV® Masterdisc











proGAV® Adjustment Disc



proGAV® Check-mate

Cat. no.	Tools
FV402T	<i>proGAV® Masterdisc</i>
FV403T	<i>proGAV® Compass</i>
FV404T	<i>proGAV® Tool Set</i> (comprising FV 400T - FV403T)
FV407T	<i>proGAV® Adjustment Disc</i>
FV408T	<i>proGAV® Adjustment Disc Set</i> (comprising FV 405T - FV407T)
FV409T	<i>proGAV® Check-mate</i>

Our Shunt Systems – Your Choice

Shunt System	Image	Description	Indication				Patient		Grav.-assist.	MR Conditional 3 Tesla
			adult HC	ped. HC	NPH	LP	active	recumbent		
<i>proSA</i> ®		Adjustable gravitational unit with differential pressure valve	X	X	X		X	X	X	X
<i>proGAV</i> ®		Adjustable differential pressure valve with gravitational unit	X	X	X		X	X	X	X
<i>GAV</i> ®		Gravitational valve for adult hydrocephalus	X		X		X		X	X
<i>paediGAV</i> ®		Gravitational valve for pediatric hydrocephalus		X			X		X	X
<i>SHUNTASSISTANT</i> ®		Gravitational unit for integration in shunt systems, to prevent overdrainage	X	X	X		X		X	X
<i>DUALSWITCH VALVE</i> ®		Gravitational valve for extra large CSF flow volume	X		X	X	X		X	X
<i>miniNAV</i> ®		Differential pressure valve especially for premature and newborn infants or recumbent, non-active patients	X	X			*	X		X
<i>MONOSTEP</i> ® VALVE		Differential pressure valve with a relatively large flow volume	X	X			*	X		X
<i>Accessories</i>										

* in combination with *SHUNTASSISTANT*® or *proSA*®



Alliance for Innovation

When two strong partners combine their expertise, innovative and groundbreaking solutions frequently arise that would scarcely have been possible working alone.

Aesculap and Miethke have followed this path and have been cooperating since 1999. In 2010 the successful partnership has been further strengthened, with the shareholding by Aesculap AG in Miethke GmbH & Co. KG. The goal was and is to develop better solutions for the difficult treatment of hydrocephalus and to make them available all over the world.

This vision has inspired and motivated everyone involved. An intensive dialogue was initiated with customers, doctors and patients about the problems associated with this complex medical condition. New solutions were developed and discussed in small circles of experts and scientific symposia.

The eventual outcome of this fruitful process was the market introduction of a gravitational unit – which can effectively reduce overdrainage of cerebrospinal fluid. A unique product worldwide and a milestone in modern hydrocephalus therapy.

What has already been achieved is only the beginning. For us, it is a duty and a necessity to continue along the path we have begun. In the patients' interest we will carry on our extensive investment into research and development and will not tire of learning more, collecting new insights and remaining open for future developments.

We will continue to venture in new directions and cross frontiers in order to be able to help where no solutions have yet been found.

Manufacturer acc. MDD 93/42/EEC

■ **CHRISTOPH MIETHKE GMBH & CO. KG**

Christoph Miethke GmbH & Co. KG | Ulanenweg 2 | 14469 Potsdam | Germany
Phone +49 331 62083-0 | Fax +49 331 62083-40 | www.miethke.com

Aesculap AG | Am Aesculap-Platz | 78532 Tuttlingen | Germany
Phone +49 7461 95-0 | Fax +49 7461 95-26 00 | www.aesculap.com

Aesculap – a B. Braun company

The main product trademark 'Aesculap' is a registered trademark of Aesculap AG. The product trademarks 'DUALSWITCH VALVE', 'GAV', 'miniNAV', 'MONOSTEP', 'paediGAV', 'proGAV', 'proSA' and 'SHUNTASSISTANT' are registered trademarks of Miethke GmbH & Co. KG.

Subject to technical changes. All rights reserved. This brochure may only be used for the exclusive purpose of obtaining information about our products. Reproduction in any form partial or otherwise is not permitted.